

RETRO300 DAB/BT

RETRO301 DAB/BT

USB/MP3/WMA/Bluetooth Digital Media Receiver

User Manual (EN)

Bedienungsanleitung (DE)

Manuale Utente (IT)

Mode d'Emploi (FR)

Manual del usuario (ES)

Overview Of The Unit

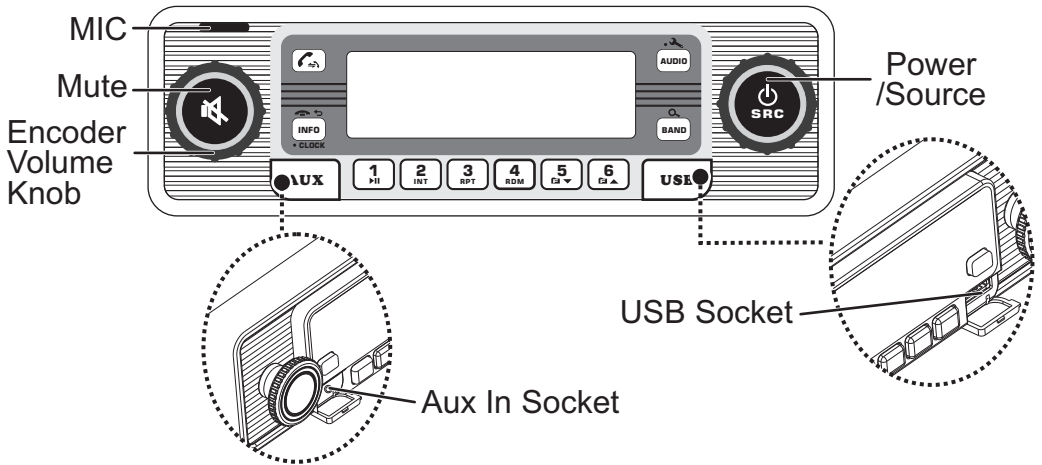

	<ul style="list-style-type: none"> • Press to Mute or Restore volume. • Rotate to adjust Volume 												
	<p>Press to answer or redial a call, press and hold to transfer the call.</p>												
	<ul style="list-style-type: none"> • Tuner Mode: Press to view RDS received information. • DAB Mode: Press repeatedly to display available information that is transmitted by a DAB radio station. • Media Playback: Press to view iD3 informations. • BT Handfree: Press to reject/end a call • Returns to the previous item. • Press and hold to view the clock. 												
	<p>Press to access into the Audio Menu, press and hold to access into the System Menu.</p>												
	<ul style="list-style-type: none"> • Tuner Mode: Select the FM bands (FM1/FM2/FM3). Press and hold to access into Auto Store mode, the six strongest stations of the selected band will be saved in preset channel automatically. • DAB Mode: Select a bands (DAB1,DAB2 or DAB3). Press to access into the list of stored stations. • Media Playback: Press to access search Folder/File music mode. 												
	<ul style="list-style-type: none"> • Turn the unit on. Press and hold again to turn the unit off. • Select the available source. • Tuner Mode: Rotate enter into the Auto Seek mode, tune and hold to enter into the Manual Seek mode. • Media Playback: Rotate to track Up/Down, tune and hold for fast Forward/Backward. 												
Preset Numeric Buttons	<ul style="list-style-type: none"> • Tuner Mode: Press the Numeric buttons to recall the preset stations. Press and hold the Numeric buttons to store the listening station. • DAB Mode: Press the buttons to store the listening station. • Media Playback: Press the Numeric buttons to perform the below operation: <table border="1" data-bbox="145 1388 683 1516"> <tbody> <tr> <td></td> <td></td> <td></td> <td></td> <td></td> <td></td> </tr> <tr> <td>Play/Pause</td> <td>Intro</td> <td>Repeat</td> <td>Random</td> <td>Folder Down</td> <td>Folder Up</td> </tr> </tbody> </table>							Play/Pause	Intro	Repeat	Random	Folder Down	Folder Up
Play/Pause	Intro	Repeat	Random	Folder Down	Folder Up								



Listen to Digital Audio Broadcasts (DAB)

Digital Audio Broadcasting (DAB), is a way of broadcasting radio digitally through a network of transmitters. It provides you with more choice, better sound quality and more information.





For the first time when DAB mode is switched on.

- Press  on the main unit repeatedly to select DAB.
 - ↳ The system performs auto scan.
 - ↳ All the available DAB stations are stored.
 - ↳ The radio tunes to the first available station





Scan For On-Air Stations

- ◆ Press and hold  **AUDIO** to enter into the System Menu.
- ◆ Press the  **AUDIO** repeatedly until [**SCAN** ←] is displayed.
- ◆ Press , the product starts scanning for on-air DAB radio stations, the detected stations are saved in the flash memory.

Antenna Power Supply 12V On/Off

- ◆ Press and hold  **AUDIO** to enter into the System Menu.
- ◆ Press the  **AUDIO** repeatedly until [**12V ON**] or [**12V OFF**] is displayed.
- ◆ Rotate  to select an option, and then press  to confirm.
 - [**12V ON**]: Enable Antenna power supply (12V).
 - [**12V OFF**]: Disable Antenna power supply (12V).

Erase The DAB Station List

- ◆ Press and hold  **AUDIO** to enter into the System Menu.
- ◆ Press the  **AUDIO** repeatedly until [**PRUNE** ←] is displayed.
 - To remove stations from the list of scanned stations, press .
 - To exit the system menu, press  **INFO**.

•CLOCK

Use Bluetooth Device

Pairing The Bluetooth Device



- ◆ On your Bluetooth-enabled device, follow the steps below.
- ◆ Search for Bluetooth devices.
- ◆ In the device list, select **DIETZ**.
Enter the default password "**0000**", and then confirm the password entry.
↳ If the pairing is successful, **[PAIRED]** will be displayed on the LCD screen of this system.

Making a Call

You can dial number through the mobile phone.

- ◆ Use the Mobile Phone to dial and make an outgoing call.
- ◆ Once completed the dialing, the phone number and **[CALL---** is displayed.

Receiving a Call





- ◆ If there is an incoming call, the phone number will be displayed. if the incoming call has no phone number, **[PHONE IN]** will be displayed.
- ◆ Press  to answer / accept the call.
- ◆ When conversation ends, press  **INFO** to terminate the call.
•CLOCK

Call Transfer



You can transfer voice from car speakers to mobile phones during a telephone conversation. During a telephone conversation, press and hold  voice transfers from car speakers to mobile phone.

Bluetooth Audio Streaming A2DP

If the connected Bluetooth device supports Advanced Audio Distribution Profile (A2DP), you can listen to the music stored on the device through the unit. If the device also supports Audio Video Remote Control Profile (AVRCP) profile, you can use the control on the unit or its remote control to play music stored on the device.



- ◆ Press  repeatedly to select **[BT AUDIO]**.
- ◆ Press  to start play, press it again to pause.
- ◆ To track up/down, rotate .
- ◆ Press  **INFO** to view song title information.
•CLOCK

Adjust Setup Menu Settings

- ◆ Press and hold  **AUDIO** to enter into the System Menu.
- ◆ Press the  **AUDIO** repeatedly to select the item to be adjusted.
- ◆ Rotate the  to select a value/option.

System Mode	Selectable Setting
CLK(Clock Set)	Adjust the Hours and Minutes
Clock Format	Select the time format 12H or 24H
Beep On/Off	Turn On or Off this beep sound
DIM (Dimmer)	Adjust the LCD display backlight level between Hight or Low
RESET	Restore the factory default settings.
TIMER	To set the power-off-timer enhancement feature (OFF/AUTO/30M/60M/90M). <ul style="list-style-type: none"> ● OFF is the powers off immediately when the ignition key is switched off. ● AUTO mode will switch off the radio with the ignition, but you can turn the radio back on (or off) for a 30-minute period. ● 30/60/90 minutes will keep playing for this time after the ignition is switched off.

Tuner Mode	Selectable Setting
RDS On/Off	Turn On or Off the RDS function.
PTY  (Program Type)	Once inside the PTY mode, press the get into program type item, and rotat encoder volume knob to selected category.
AF (Alternate Frequencies)	<ul style="list-style-type: none"> ● ON: The unit will search for another station with stronger signal, but with the same program identification as the current station automatically. ● OFF: Turn off AF function
TA (Traffic Announcement)	<ul style="list-style-type: none"> ● ON: When there is traffic announcement,unit will automatically switch to the tuner mode (regardless of the current mode) and begins to broadcast the announcemet on traffic conditions. When the traffic announcement is over, unit will automatically return to the previous mode. ● OFF: Traffic announcement does not cut in.
CT (Clock Time)	<ul style="list-style-type: none"> ● ON: Turn on the RDS clock. Time shown on the unit will synchronizes with the clock time of the RDS station. ● OFF: Turn off the RDS clock.
Loc On/Off	<ul style="list-style-type: none"> ● ON: Only stations with strong signal can be broadcast. The Local indicator will light up. ● OFF: Stations of both strong and weak signals can be broadcast.
Area	Select suitable country area for this unit: EUROPE; ASIA;MID-EAST; AUSTRALIA;USA; LATIN; JAPAN;RUSSIA;

BT Mode	Selectable Setting
RE-CON  DIS-CON 	This feature allows to Re-connect or Dis-connect to the paired mobile phone or Bluetooth device by manually.
UNPAIR 	To unpair the paired mobile phone

Listening To External Device

Playing a USB Device

- ◆ Flip open the USB cover, and Insert the USB device into the USB socket.
- ◆ Press the  to select USB mode, the unit starts playing from the USB device.

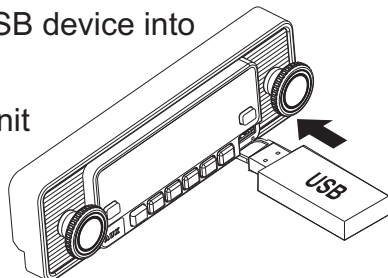

Listening To External Aux Input

- ◆ Press the  to select AUDIO IN mode.
- ◆ Turn on the external component and start playing.

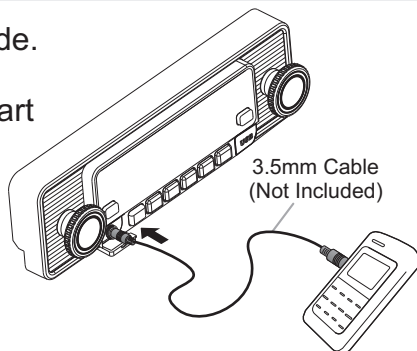

USB Smart Phone 1A Charging

- ◆ Flip open the USB cover, and Insert the iPhone /Smart Phone device into the USB socket.
- ◆ Once the iPhone/Smart Phone is connected and recognized, the iPhone/Smart Phone begins to charge.

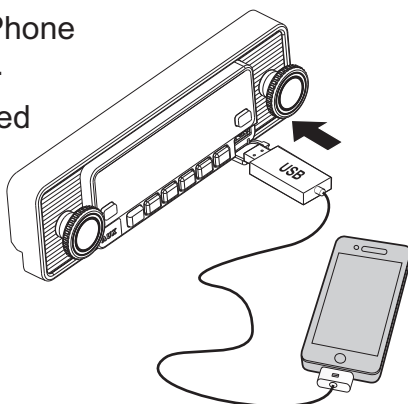

NOTE

This USB only can charge Phones, but cannot play or decode music files stores inside the Smart Phones.

Installing The Unit

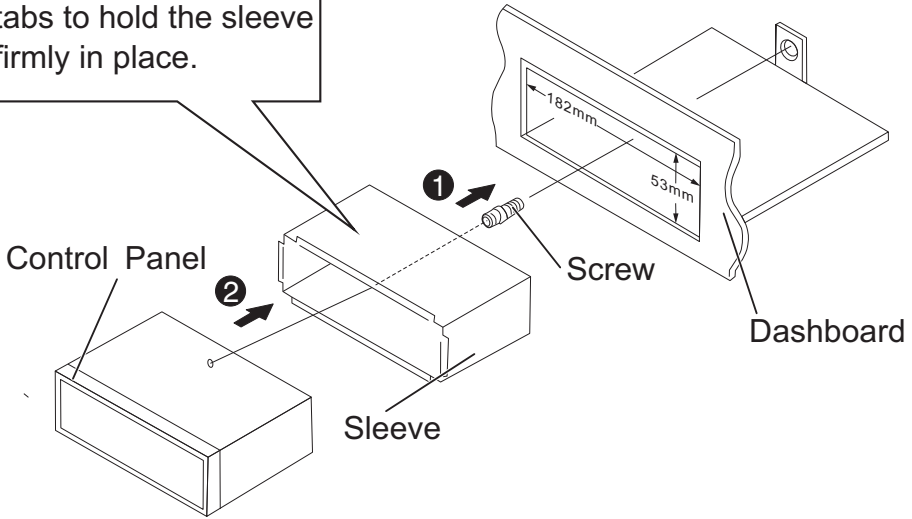
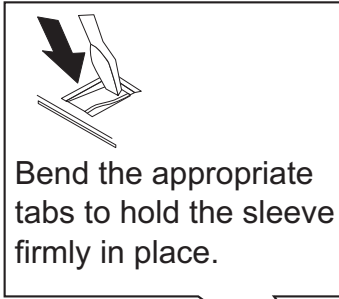

Remove The Unit

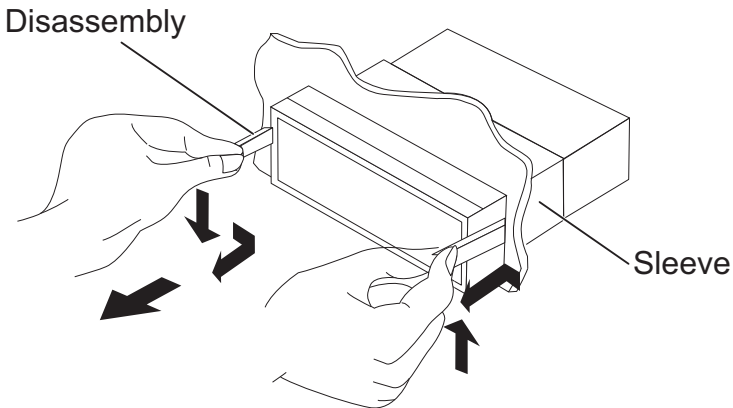

Wiring Diagram

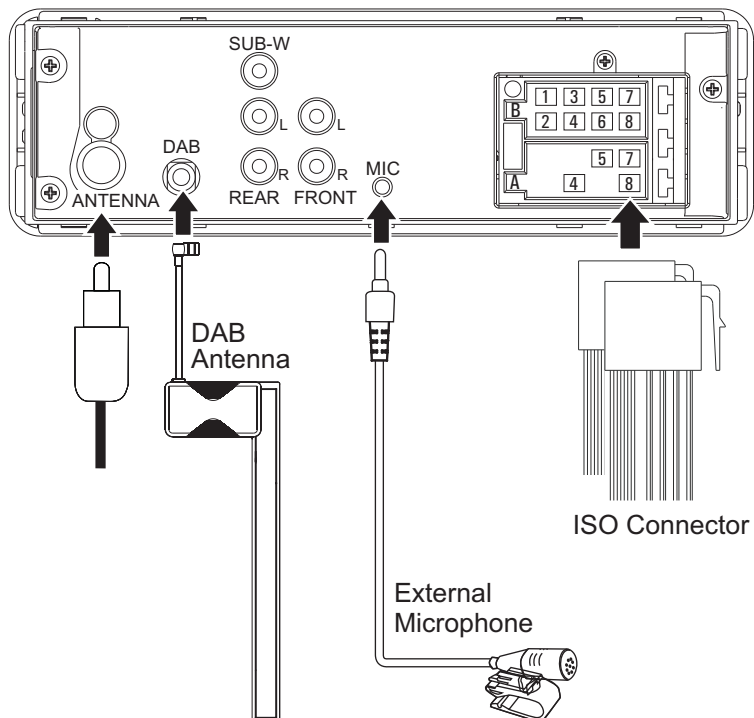





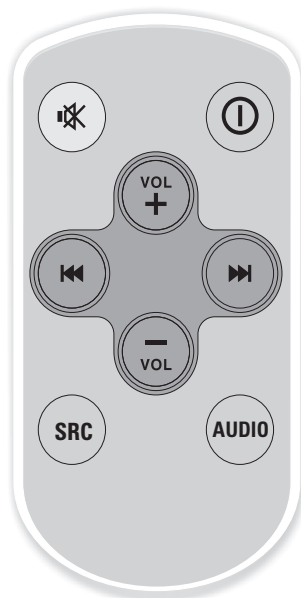

ISO Connector Wiring Chart

Pin	Color and Function	Pin	Color and Function	
A4	Yellow Battery(+)	B1/B2	Violet ⊕ Violet/Black ⊖	Right rear speaker
A5	Blue Connect to system control terminal of the power AMP or auto antenna relaycontrol terminal (Max150mA/12VDC)	B3/B4	Grey ⊕ Grey/Black ⊖	Right front speaker
A7	Red Ignition(ACC)	B5/B6	White ⊕ White/Black ⊖	Left front speaker
A8	Black Ground	B7/B8	Green ⊕ Green/Black ⊖	Left rear speaker

Remote Control Operation



	Press to mute or restore volume.
	Turn unit On or Off.
	Press increases the volume.
	Press decreases the volume.
	<ul style="list-style-type: none">◆ Tuner Mode: Press access into the Auto Seek mode, press and hold access into the Manual Seek mode.◆ Media Playback Mode: Press to track Up/Down, press and hold for fast Forward/Backward.
	Select the available Source.
	Press to access into the Audio Menu mode.

Product Specifications

General

Power Supply	12V DC (11V to 16V), negative ground	
Suitable speaker impedance	4-8 Ω	
Maximum power output	50W x 4	
Continous power output	20W x 4RMS (4 Ω 10%T.H.D)	
Pre-AMP output voltage	2.0V	

Radio Tuner

Frequency Range	FM	87.5MHz to 108.0MHz
FM Tuner	Usable Sensitivity (S/N=20dB)	0.8uV

DAB Tuner

Frequency Range	174 - 240MHz	
Sensitivity	-100dBm(Band III)	
Selectivity	40dB	

USB Device

USB	USB2.0 Full speed	
USB Port	Type A	
USB Voltage	5.0V	
Maximum USB Memory Size	32G	
USB Flash Drive and Hard	FAT16/FAT32	

Bluetooth

Output Power	Class 2	
Frequency Band	2.4000 Ghz - 2.4835GHz ISM Band	
Range	3 meters (free space)	
Standard	Bluetooth 2.1 specification	
Compatible Bluetooth Profiles	Hands-Free Profiles (HFP) A2DP(Advanced Audio Distribution Profile) AVRCP1.3(Audio/Video Remote Control Profile)	

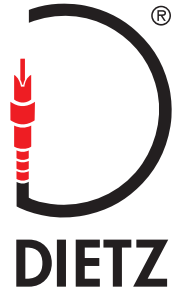

RETRO300 DAB/BT









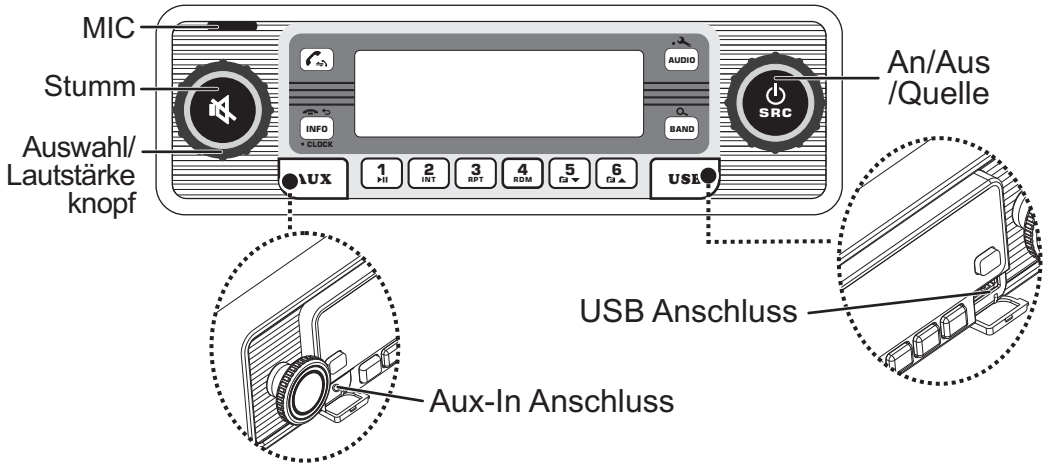



RETRO301 DAB/BT

USB/MP3/WMA/Bluetooth Digital Media Receiver

Bedienungsanleitung

Überblick



	<ul style="list-style-type: none"> • Drücken: Stummschaltung und Beendigung. • Drehen: Lautstärke anpassen.
	Drücken: Gesprächsannahme oder Wahlwiederholung; Drücken und halten: Lautsprecher aus
	<ul style="list-style-type: none"> • UKW Modus: Drücken Sie, um RDS Information zu sehen. • DAB+ Modus: Drücken Sie wiederholt, um verfügbare Informationen anzuzeigen, die von einem DAB-Radiosender übertragen werden. • USB Modus: Drücken Sie, um ID3-Informationen anzuzeigen. • Bluetooth Freisprechen: Drücken Sie, um einen Anruf abzulehnen/beenden. • Zurück zur vorherigen Einstellung. • Drücken und halten, um die Uhr zu sehen.
	Drücken: Audio-Menü; Drücken und halten: System-Menü.
	<ul style="list-style-type: none"> • UKW: Wählen Sie die UKW-Bänder (FM1/FM2/FM3). Drücken und halten Sie, um in den Autospeicher-Modus zu gelangen. Es werden die 18 stärksten Stationen des ausgewählten Bandes automatisch gespeichert. • DAB+: Wählen Sie ein Band (DAB1, DAB2 oder DAB3). Drücken Sie, um in die Liste der gespeicherten Stationen zu gelangen. • USB: Drücken Sie, um die Ordner anzuzeigen.
	<ul style="list-style-type: none"> • Schalten Sie die Einheit an. Drücken und halten Sie erneut, um auszuschalten. • Wählen Sie die verfügbare Quelle aus. • UKW: Leicht andrehen: automatischer Suchmodus; Andrehen und halten Sie, um in den manuellen Suchmodus zu gelangen. • USB: Drehen für Lied Vor/Zurück; Drehen & Halten schnell Vor/Zurück im Lied.
	<ul style="list-style-type: none"> • UKW: Drücken Sie die numerischen Tasten, um die voreingestellten Stationen abzurufen. Drücken und halten Sie eine Taste lange, um einen Sender zu speichern. • DAB+: Drücken Sie eine Zahlentaste, um den aktuellen Sender zu speichern. • Media Playback: Drücken Sie die Tasten, um auszuführen:
	<div style="display: flex; justify-content: space-around; align-items: center;"> <div style="text-align: center;">  Play/Pause </div> <div style="text-align: center;">  Ansp. </div> <div style="text-align: center;">  Wied. </div> <div style="text-align: center;">  Zufall </div> <div style="text-align: center;">  Ordner ab </div> <div style="text-align: center;">  Ordner auf </div> </div>



Hören Sie Digitalradio (DAB+)

Digital Audio Broadcasting (DAB) ist eine Möglichkeit, Radio digital über ein Netzwerk von Sendern zu übertragen. Es bietet Ihnen mehr Auswahl, bessere Klangqualität und mehr Informationen.





Zum ersten Mal, wenn der DAB-Modus eingeschaltet ist:

- Drücken Sie  wiederholt auf "SRC", um DAB auszuwählen.
 - ↳ Das System führt einen automatischen Scan durch.
 - ↳ Alle verfügbaren DAB-Stationen sind hinterlegt.
 - ↳ Der erste verfügbare Sender wird abgespielt.





Suchlauf für "On-Air" Stationen

- ◆ Drücken & halten Sie  **AUDIO** um in das System Menü zu gelangen.
- ◆ Drücken Sie  **AUDIO** bis [**SCAN** ←] erscheint.
- ◆ Drücken Sie , der Suchlauf beginnt für verfügbare Sender, die erkannten Stationen werden im Flash-Speicher gespeichert.

Antennen Phantom-Spannung 12V An/Aus

- ◆ Drücken und halten Sie  **AUDIO** um in das System Menü zu gelangen.
- ◆ Drücken Sie  **AUDIO** wiederholt bis [**12V ON**] oder [**12V OFF**] erscheint.
- ◆ Drehen Sie  um eine Auswahl festzulegen und drücken Sie  um zu bestätigen.
 - [**12V ON**]: Aktivierte Antennen-Phantomspannung (12V).
 - [**12V OFF**]: Abgeschaltete Antennen-Phantomspannung (12V).

Löschen der DAB+ Senderliste

- ◆ Drücken und halten Sie  **AUDIO** um in das System Menü zu gelangen
- ◆ Drücken Sie  **AUDIO** wiederholt bis [**PRUNE** ←] erscheint.
 - Um Stationen aus der Liste der gescannten Stationen zu entfernen, drücken Sie 
 - Um das System Menü zu verlassen, drücken Sie 

Bluetooth benutzen



Kopplung eines Gerätes

- ◆ Führen Sie auf Ihrem Bluetooth-Gerät die folgenden Schritte aus.
- ◆ Suchen Sie nach Bluetooth-Geräten.
- ◆ Wählen Sie in der Geräteliste **DIETZ** aus.
Geben Sie das Passwort "**0000**"; ein und bestätigen Sie dann die Eingabe des Passworts.
↳ Wenn die Kopplung erfolgreich ist, wird **[PAIRED]** auf dem LCD-Bildschirm dieses Systems angezeigt.

Ein Gespräch führen

- Sie können die Nummer nur über das Mobiltelefon wählen.
- ◆ Verwenden Sie das Mobiltelefon, um zu wählen und einen abgehenden Anruf zu tätigen.
 - ◆ Sobald die Wahl abgeschlossen ist, wird die Telefonnummer und **[CALL---** angezeigt.

Gesprächsannahme

- ◆ Bei einem eingehenden Anruf wird die Telefonnummer angezeigt. Wenn der eingehende Anruf keine Telefonnummer hat, wird **[PHONE IN]** angezeigt.
- ◆ Drücken Sie  um den Anruf zu beantworten/anzunehmen.
- ◆ Wenn das Gespräch endet, drücken Sie  um das Gespräch zu beenden.

Gesprächswiedergabe





Während eines Telefongesprächs können Sie die Stimme von den Autolautsprechern auf das Mobiltelefon übertragen. Drücken und halten Sie während eines Telefongesprächs





für die Sprachübertragung von den Autolautsprechern auf das Mobiltelefon.

Bluetooth Audio Streaming A2DP

Wenn das angeschlossene Bluetooth-Gerät das Advanced Audio Distribution Profile (A2DP) unterstützt, können Sie die auf dem Gerät gespeicherte Musik über das Gerät hören. Wenn das Gerät auch das Profil Audio Video Remote Control Profile (AVRCP) unterstützt, können Sie die Steuerung des Geräts oder seine Fernbedienung verwenden, um auf dem Gerät gespeicherte Musik abzuspielen.



- ◆ Drücken Sie  wiederholt, um **[BT AUDIO]** auszuwählen,
- ◆ Drücken Sie  für Play und wiederholt für Pause.
- ◆ Für Vor/Zurück drehen .
- ◆ Drücken Sie  um Titelinformationen anzuzeigen.

Einstellungen im Setup-Menü anpassen

- ◆ Drücken und halten Sie  **AUDIO** um in das System Menü zu wechseln.
- ◆ Drücken Sie  **AUDIO** wiederholt um die gewünschte Einstellung auszuwählen.
- ◆ Drehen Sie  um einen Wert/Option zu verändern.

System Modus	Auswählbare Einstellung
CLK(Uhr)	Anpassung der Stunden und Minuten
Clock Format	Wählen Sie das Zeitformat 12H oder 24H
Beep On/Off	Schalten Sie den Piepton ein oder aus
DIM (Dimmer)	Anpassen des LCD-Display-Hintergrundbeleuchtungspegels zwischen Hoch oder Niedrig
RESET	Wiederherstellen der Werkseinstellungen
TIMER	So stellen Sie die Power-Off-Timer-Verbesserungsfunktion (OFF/AUTO/30M/60M/90M) ein. <ul style="list-style-type: none"> ● AUS ist das Ausschalten sofort, wenn der Zündschlüssel ausgeschaltet ist. ● Der AUTO-Modus schaltet das Radio mit der Zündung aus, aber Sie können das Radio für einen Zeitraum von 30 Minuten wieder einschalten (oder ausschalten). ● 30/60/90 Minuten Betrieb, nachdem die Zündung ausgeschaltet ist.

Radio Modus	Auswählbare Einstellung
RDS An/Aus	Schalten Sie die RDS-Funktion ein oder aus.
PTY  (Programm Typ)	Sobald sie in dem PTY-Modus sind, drücken Sie den Lautstärkeknopf und wählen Sie durch drehen die gewünschte Kategorie aus.
AF (Alternative Frequenz)	<ul style="list-style-type: none"> ● ON: Die Einheit wird nach einem anderen Sender mit stärkerem Signal suchen, aber mit der gleichen Programm-Identifikation wie der aktuelle Sender. ● OFF: Ausschalten der AF-Funktion
TA (Verkehrsmeldung)	<ul style="list-style-type: none"> ● ON: Wenn es Verkehrsdurchsagen gibt, wechselt das Radio automatisch auf den UKW-Modus (unabhängig von dem aktuellen Modus) und beginnt, die Ansage über Verkehrsmeldungen zu senden. Wenn die Verkehrsdurchsage beendet ist, kehrt das Gerät automatisch in den vorherigen Modus zurück. . ● OFF: Verkehrsdurchsagen ausgeschaltet.
CT (Uhrzeit)	<ul style="list-style-type: none"> ● ON: Schalten Sie die RDS-Uhr ein. Die auf dem Gerät angezeigte Zeit ist die Uhrzeit der aktuellen UKW-Station. ● OFF: Ausschalten der RDS-UHR.
Loc An/Aus	<ul style="list-style-type: none"> ● ON: Nur Sender mit starkem Signal können gesendet werden. Die Anzeige "LOCAL" wird aufleuchten. ● OFF: Es können Sender mit starken und schwachen Signalen ausgestrahlt werden.
Area	Wählen Sie ein geeignetes Land für dieses Gerät: EUROPE; ASIA;MID-EAST; AUSTRALIA;USA; LATIN; JAPAN;RUSSIA;

BT Modus	Auswählbare Einstellung
RE-CON  DIS-CON 	Diese Funktion ermöglicht es, die Verbindung mit dem Bluetooth-Gerät per Hand wieder herzustellen (RE-CON) oder zu trennen (DIS-CON).
UNPAIR 	Um das gekoppelte Handy zu entkoppeln.

Abspielen von externen Geräten

Abspielen von USB

- ◆ Öffnen Sie die USB-Abdeckung, stecken Sie den USB Stick in den USB Anschluss.
- ◆ Drücken Sie  um den USB-Modus zu wählen, das Gerät vom USB Stick abzuspielen.

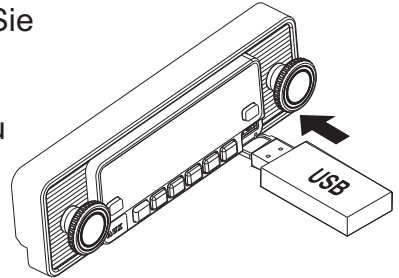

Abspielen über AUX-Eingang

- ◆ Drücken Sie  um den AUDIO-IN Modus zu wählen.
- ◆ Schalten Sie das externe Geräte ein und drücken Sie START.

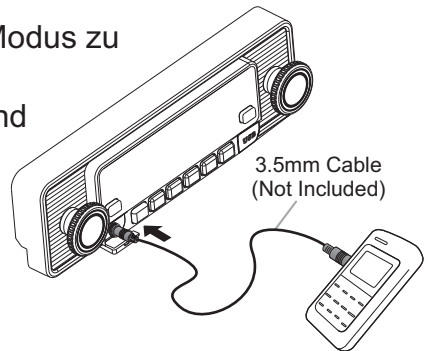

USB Smartphone 1A Laden

- ◆ Öffnen Sie die USB-Abdeckung und schließen Sie das Smartphone über USB an.
- ◆ Sobald das Smartphone verbunden und erkannt ist, wird das Smartphone geladen.

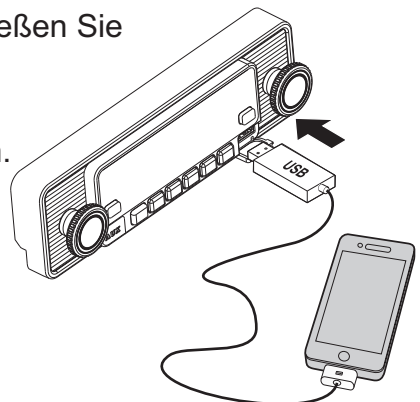

NOTE

Dieser USB Anschluss kann nur Telefone aufladen, kann aber keine Musikdateien von Smartphones abspielen oder dekodieren.

Installation des Radios

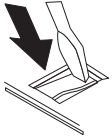

Biegen Sie die entsprechenden Laschen, um den Rahmen fest an Ort und Stelle zu halten.

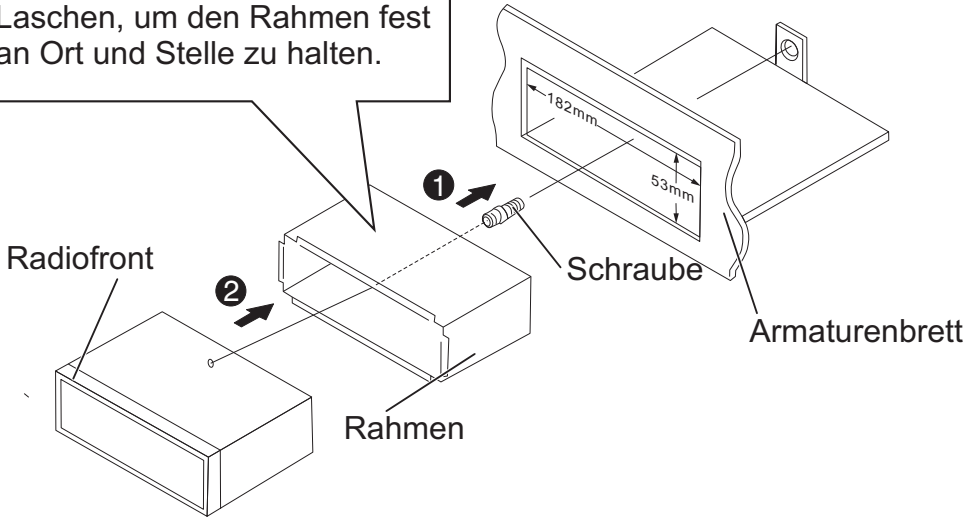

Ausbau des Radios

Demontage

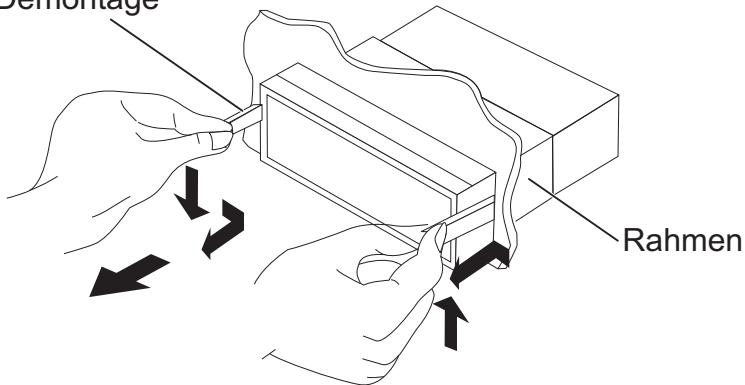

Anschluss-Schema

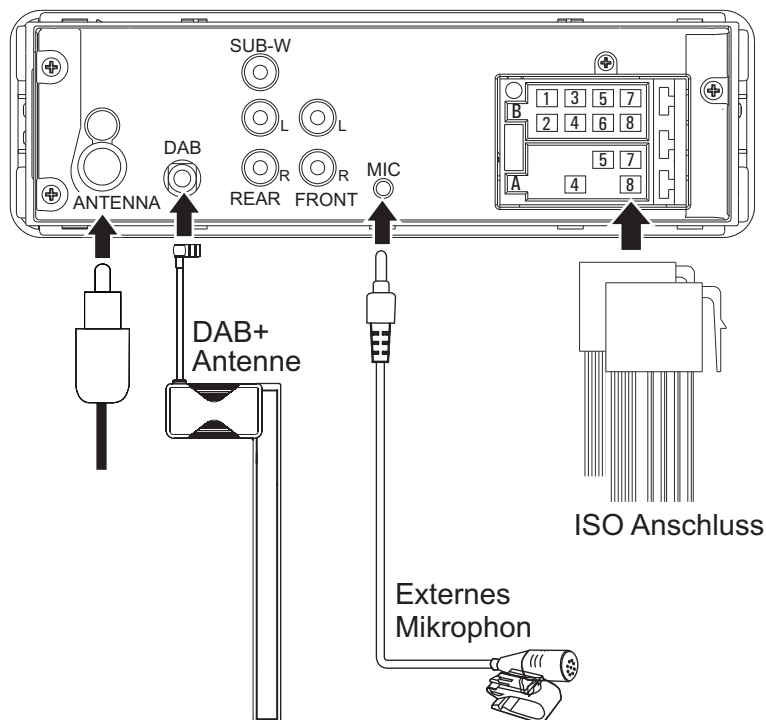

ISO Anschluss Schema

Pin	Farbe und Funktion		Pin	Farbe und Funktion	
A4	Gelb	Batterie(+)	B1/B2	Lila [⊕] Lila/Schwarz [⊖]	Lautsprecher rechts hinten
A5	Blau	Einschaltleitung, zum Beispiel für Verstärker oder Motorantenne, (max.150mA,12VDC)	B3/B4	Grau [⊕] Grau/Schwarz [⊖]	Lautsprecher rechts vorne
A7	Rot	Zündung(ACC)	B5/B6	Weiß [⊕] Weiß/Schwarz [⊖]	Lautsprecher links vorne
A8	Schwarz	Masse	B7/B8	Grün [⊕] Grün/Schwarz [⊖]	Lautsprecher links hinten

Fernbedienung

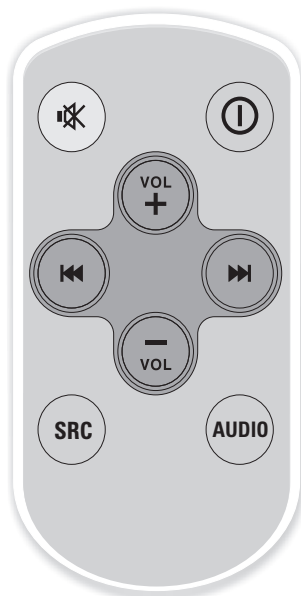

	Drücken Sie zum Stummschalten oder Wiederherstellen der Lautstärke.
	Schalten Sie die Einheit ein oder aus.
	Drücken erhöht die Lautstärke.
	Drücken verringert die Lautstärke.
	◆ Radio Modus: Drücken: Auto Such-Modus; Drücken und halten: Manueller Such-Modus.
	◆ USB Modus: Drücken Sie, um Up/Down zu starten, drücken und halten Sie für schnellen Suchlauf im Lied.
SRC	Drücken Sie, um eine Quelle auszuwählen.
AUDIO	Drücken Sie, um in den Audio-Menü-Modus zu gelangen.

Produkt Spezifikationen

Generelles

Stromversorgung	12V DC (11V to 16V), negativ: Masse
Lautsprecherimpedanz	4-8 Ω
Maximale Leistung	50W x 4
Dauerleistung	20W x 4RMS (4 Ω 10%T.H.D)
Vorverstärkerpegel	2.0V

UKW Empfänger

Frequenzbereich	UKW	87.5MHz to 108.0MHz
FM Tuner	Sensibilität (S/N=20dB)	0.8uV

DAB+ Empfänger

Frequenzbereich	174 - 240MHz
Sensibilität	-100dBm(Band III)
Selektivität	40dB

USB Gerät

USB	USB 2.0
USB Anschluss	Type A
USB Spannung	5.0V
Maximum USB Memory Size	32G
USB Flash Drive and Hard	FAT16/FAT32

Bluetooth

Ausgangsleistung	Class 2
Frequenzband	2.4000 Ghz - 2.4835GHz ISM Band
Reichweite	3 meters (im Freiraum)
Standard	Bluetooth 2.1 Spezifikation
Kompatible Bluetooth Profile	Freisprech-Profil (HFP) A2DP(Advanced Audio Distribution Profile) AVRCP1.3(Audio/Video Remote Control Profile)

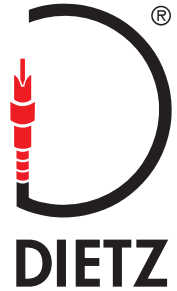

RETRO300 DAB/BT
RETRO301 DAB/BT

Autoradio Bluetooth con ricevitore Digital Media
USB/MP3/WMA

Manuale Utente

Guida all'unità

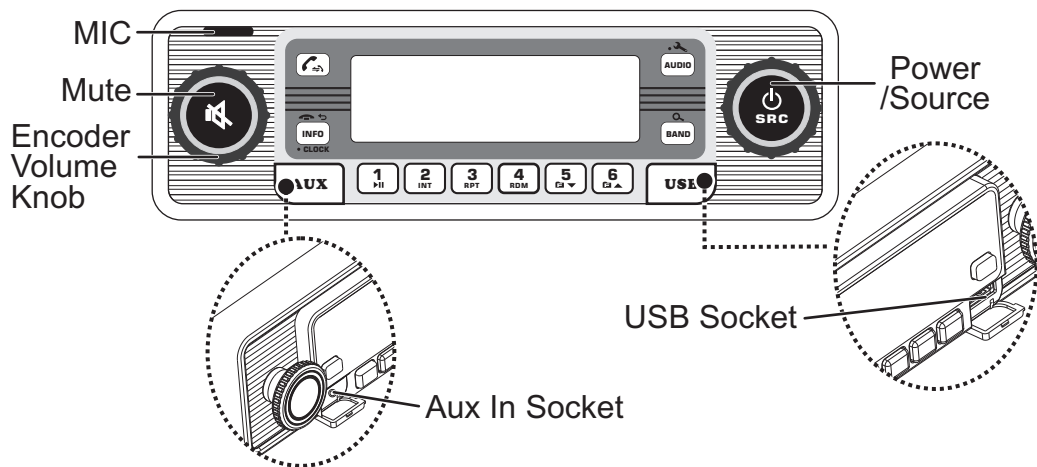

	<ul style="list-style-type: none"> • Premere per mettere in Mute o ripristinare il Volume • Ruotare per regolare il Volume 												
	<p>Premere per rispondere o digitare una chiamata nuovamente, premere e tenere premuto per trasferire la chiamata.</p>												
	<ul style="list-style-type: none"> • Mod. Tuner: Premere per vedere le informazioni ricevute dal RDS. • Mod. DAB: Premere ripetutamente per visualizzare le informazioni disponibili trasmesse da una radiostazione DAB suldisplay. • Riproduzione Media: Premere per visualizzare i tag iD3. • Viva voce BT: Premere per rifiutare/terminare una chiamata • Torna alla voce precedente. • Premere e tenere premuto per visualizzare l'orologio 												
	<p>Premere per accedere al Menu Audio, premere e tenere premuto per accedere al Menu di Sistema.</p>												
	<ul style="list-style-type: none"> • Mod. Tuner: Selezionare le bande FM (FM1/FM2/FM3). Premere e tenere premuto per accedere alla modalità Memorizzazione Automatica. Le sei stazioni con segnale più forte nella banda selezionata saranno memorizzate automaticamente nel canale preselezionato. • Mod. DAB: Selezionare le bande (DAB1, DAB2 o DAB3). Premere e tenere premuto per accedere alla lista delle stazioni memorizzate. • Riproduzione Media: Premere per accedere o cercare Cartelle/File musicali. 												
	<ul style="list-style-type: none"> • Accendere l'apparecchio. Premere e tenere premuto per spegnerlo. • Selezionare la sorgente disponibile. • Mod. Tuner: Ruotare enter nella modalità Auto Seek, sintonizzare e tenere premuto per entrare in modalità ricerca Manuale. • Riproduzione Media: Ruotare per scorrere Su/Giù, sintonizzare e tenere premuto per avanzare/indietreggiare velocemente. 												
	<ul style="list-style-type: none"> • Mod. Tuner: Premere i tasti numerici per richiamare le stazioni preselezionate. Premere e tenere premuto i tasti numerici per memorizzare la stazione corrente. • Mod. DAB: Premere i tasti numerici per memorizzare la stazione corrente. • Riproduzione Media: Premere i tasti numerici per le seguenti operazioni: 												
	<table style="width: 100%; text-align: center;"> <tr> <td></td> <td></td> <td></td> <td></td> <td></td> <td></td> </tr> <tr> <td>Play/Pause</td> <td>Intro</td> <td>Ripeti</td> <td>Casuale</td> <td>Cartella Seguente</td> <td>Cartella Precedente</td> </tr> </table>							Play/Pause	Intro	Ripeti	Casuale	Cartella Seguente	Cartella Precedente
Play/Pause	Intro	Ripeti	Casuale	Cartella Seguente	Cartella Precedente								



Ascoltare le trasmissioni digitali AUDIO (DAB)

Il Digital Audio Broadcasting (DAB), è una modalità digitale radio che funziona tramite una rete di trasmettitori. Dà la possibilità di una scelta più vasta, grande qualità audio e maggiori informazioni.





Per la prima accensione della modalità DAB.

- Premere  questo tasto sull'apparecchio per selezionare DAB.
 - ↳ Il Sistema scansiona automaticamente.
 - ↳ Tutte le stazioni DAB disponibili vengono memorizzate.
 - ↳ La radio si sintonizza sulla prima stazione disponibile.





Scansiona Stazioni On-Air

- ◆ Tenere premuto  per entrare nel Menu di Sistema.
- ◆ Premere  **AUDIO** più volte per trovare questa funzione [**SCAN** ←] .
- ◆ Premere  perché l'apparecchio scansioni le stazioni radio DAB on – air, le stazioni rilevate vengono memorizzate nella memoria flash.

Accendere l'alimentazione Antenna 12V

- ◆ Tenere premuto  per entrare nel Menu di Sistema.
- ◆ Premere  **AUDIO** più volte fino a visualizzare [**12V ON**] o [**12V OFF**].
- ◆ Ruotare  per selezionare un'opzione e premere  per confermare.
 - [**12V ON**]: Attivare l'alimentazione Antenna (12V).
 - [**12V OFF**]: Disattivare l'alimentazione Antenna (12V).

Cancellare la lista delle stazioni DAB

- ◆ Tenere premuto  per entrare nel Menu di Sistema.
- ◆ Premere  **AUDIO** ripetutamente fino a che appare [**PRUNE** ←] .
 - Per rimuovere le stazioni dalla lista premere il tasto .
 - Per uscire dal menu di sistema:  **INFO**.

• CLOCK

Utilizzare l'apparecchio Bluetooth

Effettuare il Pairing del dispositivo Bluetooth

- ◆ Sul vostro dispositivo abilitato Bluetooth seguire i passaggi seguenti
- ◆ Ricercare gli apparecchi Bluetooth
- ◆ Nella lista degli apparecchi selezionare **DIETZ**.
Digitare la password di default "**0000**", e confermare.
↳ Se il pairing è stato completato, la scritta **[PAIRED]** apparirà sullo schermo LCD del sistema.

Effettuare una chiamata

- È possibile digitare un numero sul telefono cellulare.
- ◆ Utilizzare il telefonino per digitare il numero ed effettuare una chiamata.
 - ◆ Una volta terminate, viene visualizzato il numero e la scritta **[CALL---**].

Ricevere una chiamata

- ◆ In caso di chiamata entrante, viene visualizzato il numero del chiamante. Se questo non è presente, la scritta **[PHONE IN]** sarà visualizzata sul display.
- ◆  Questo tasto permette di rispondere/accettare la chiamata.
- ◆ Premendo questo tasto  si termina la conversazione

Trasferimento di chiamata





È possibile trasferire la chiamata dagli altoparlanti dell'auto al telefono cellulare durante una conversazione telefonica. È sufficiente premere e





tenere premuto il tasto per trasferirla.

Audio Streaming Bluetooth A2DP

Se l'apparecchio Bluetooth connesso supporta il formato Advanced Audio Distribution Profile (A2DP), è possibile ascoltare la musica memorizzata sull'apparecchio tramite l'unità. Se inoltre l'apparecchio supporta anche la funzione Audio Video Remote Control Profile (AVRCP), è possibile utilizzare i comandi dell'autoradio o il suo telecomando per riprodurre la musica memorizzata sull'apparecchio.



- ◆ Premere  ripetutamente per selezionare **[BT AUDIO]**.
- ◆ Premere  per avviare la riproduzione e nuovamente per mettere in pausa.
- ◆ Per scorrere su o giù SRC .ruotare questa manopola .
- ◆ Premere  per visualizzare il titolo o le info del brano.

Regolare le impostazioni del Menu

- ◆ Tenere premuto  **AUDIO** per accedere al Menu di Sistema
- ◆ Premere  **AUDIO** più volte per selezionare la voce da regolare
- ◆ Ruotare  la manopola per selezionare un valore /opzione.

Mod. Sistema	Impostazioni selezionabili
CLK (Orologio)	Regolare Ore e Minuti
Clock Format	Per selezionare il formato orario (12H o 24H)
Beep On/Off	Accende o spegne il suono del bip
DIM (Dimmer)	Regola il livello di retroilluminazione del display LCD display tra High o Low (alto o basso)
RESET	Ripristina le impostazioni di default di fabbrica
TIMER	Per impostare lo spegnimento (OFF/AUTO/30M/60M/90M). <ul style="list-style-type: none">● OFF si spegne immediatamente allo spegnimento dell'auto.● AUTO permette lo spegnimento della radio assieme all'auto ma è possibile riaccendere la radio di nuovo (o spegnerla) per un periodo di 30minuti.● 30/60/90 sono le opzioni in minuti per mantenere accesa l'autoradio dopo che l'auto è stata spenta.

Mod. Tuner	Impostazioni selezionabili
RDS On/Off	Accende o spegne la funzione RDS.
PTY  (Program Type)	Una volta attivata la modalità PTY, premere e ruotare la manopola volume per accedere alla categoria di programmi selezionata
AF (Alternate Frequencies)	<ul style="list-style-type: none">● ACCESA: L'unità ricercherà la stessa stazionema su frequenze con un segnale più forte automaticamente.● SPENTA: Spegne la funzione AF.
TA (Traffic Announcement)	<ul style="list-style-type: none">● ACCESA: In caso di annunci sul traffico, l'autoradio automaticamente si posiziona sulla stazione che li sta trasmettendo (nonostante la modalità in corso) ed inizia a trasmetterli. Una volta terminati, automaticamente ritorna alla modalità precedente.● SPENTA: Non ci saranno interruzioni sul Traffico.
CT (Clock Time)	<ul style="list-style-type: none">● ACCESA: Attiva l'orologio RDS. L'orario mostrato sul display si sincronizza con quello dell'emittente RDS che si sta ascoltando.● SPENTA: Disattiva l'orologio RDS.
Loc On/Off	<ul style="list-style-type: none">● ACCESA: Rileva solo le stazioni con il segnale più forte. L'indicatore Local si accenderà.● SPENTA: Saranno rilevate stazioni il cui segnale sarà forte o debole.
Area	Selezionare il tipo di area (continente) nel quale ci si trova: EUROPA; ASIA;MEDIO ORIENTE, AUSTRALIA;USA; LATINI; GIAPPONE;RUSSIA;

Mod. BT	Impostazioni selezionabili
RE-CON  DIS-CON 	Questa funzione permette il RI-collegamento oppure lo scollegamento di apparecchi che hanno effettuato il pairing e il Bluetooth manualmente.
UNPAIR 	Per eliminare il pairing allo smartphone collegato

Ascoltare apparecchi esterni

Riprodurre un apparecchio con uscita USB

- ◆ Aprire la copertura dell'entrata USB ed inserire l'apparecchio USB.
- ◆ Premere  per selezionare la modalità USB, l'unità inizierà a riprodurre dall'apparecchio USB.

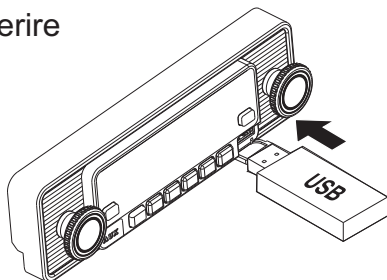

Ascoltare tramite l'ingresso

- ◆ Premere  per selezionare la modalità AUDIO IN.
- ◆ Accendere l'apparecchio esterno e avviare la riproduzione.

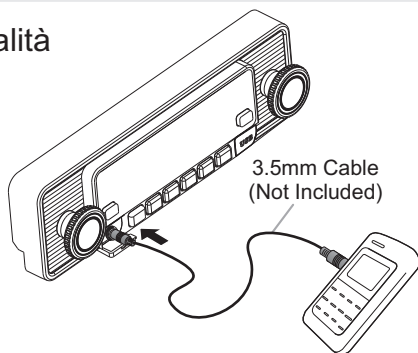

Carica dello Smartphone tramite USB (1A)

- ◆ Aprire la copertura dell'entrata USB ed inserire iPhone/Smartphone tramite USB.
- ◆ Una volta che l'iPhone/Smartphone è connesso, inizia a caricarsi.

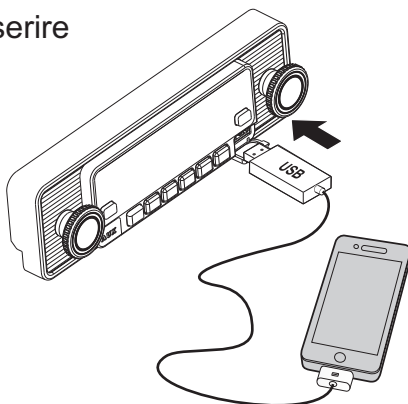

NOTE

La presa USB può caricare il telefono ma non può riprodurre file musicali memorizzati sul telefono.

Installare l'Unità

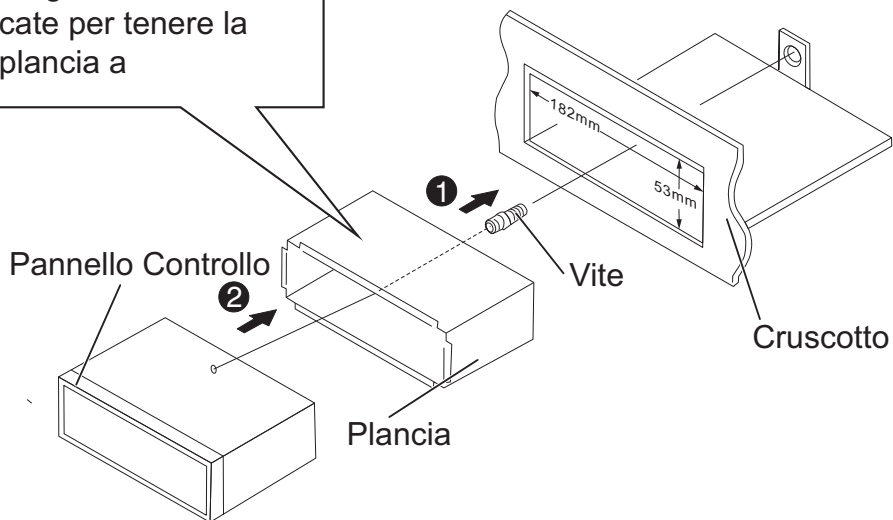
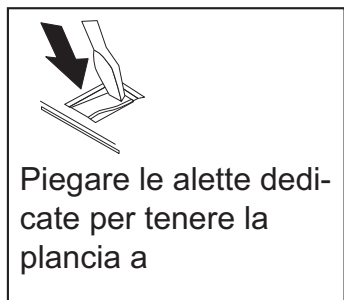

Estrarre l'Unità

Smontaggio

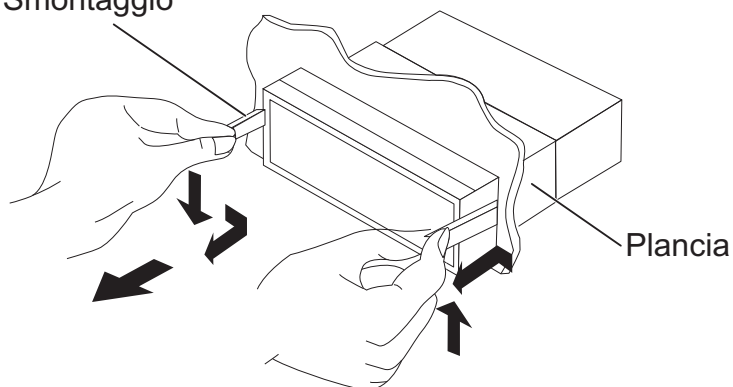

Schema Elettrico

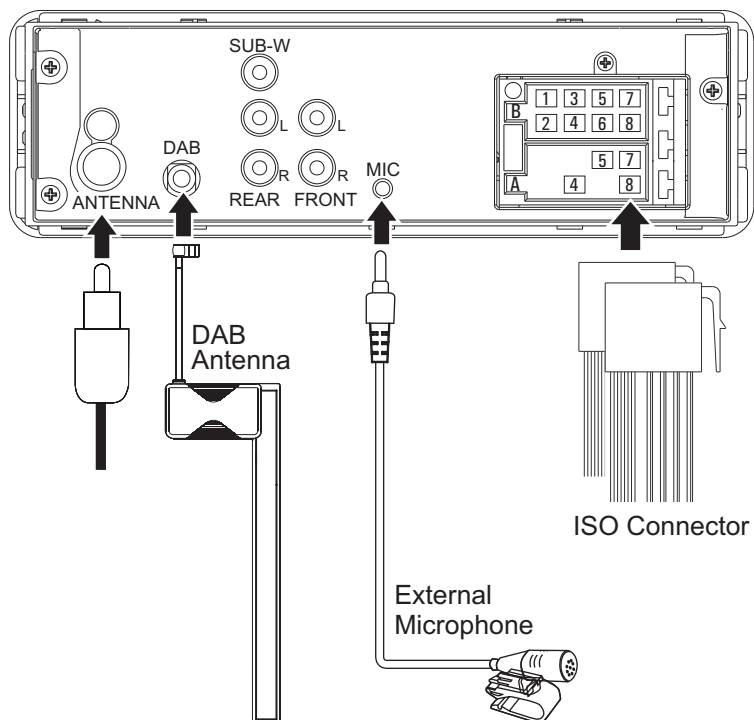





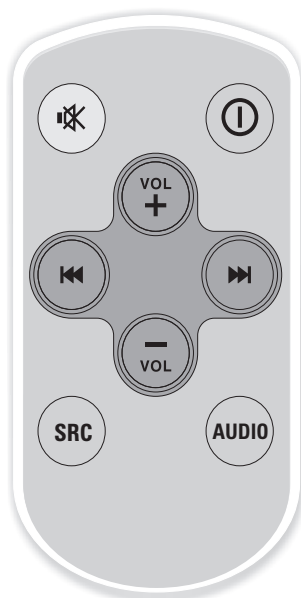

Schema dei collegamenti Connettore ISO

Pin	Colore e Funzione	Pin	Colore e Funzione	
A4	Giallo Batteria(+)	B1/B2	Viola ⊕ Viola/Nero ⊖	Altop. posteriore destro
A5	Blu Collegare al terminal dell'amplificatore di potenza o al relè antenna (Max 150mA/12VDC)	B3/B4	Grigio ⊕ Grigio/Nero ⊖	Top anteriore controllo Sistema
A7	Rosso Avviamento(ACC)	B5/B6	Bianco ⊕ Bianco/Nero ⊖	Altopant sinistro
A8	Nero Massa	B7/B8	Verde ⊕ Verde/Nero ⊖	Altop post sinistro

Funzionamento Telecomando



	Premere per mettere in mute o ripristinare il volume
	Accende o spegne l'apparecchio.
	Premere per aumentare il volume.
	Premere per diminuire il volume.
	<ul style="list-style-type: none">◆ Tuner Mode: Premere per accedere alla modalità di ricerca automatica (Auto Seek) premere e tenere premuto per accedere alla ricerca manuale (Manual Seek).◆ Riproduzione Media: Premere per scorrere Su/Giù, premere e tenere premuto per avanzare /indietreggiare velocemente.
	Selezionare la Sorgente disponibile.
	Premere per accedere al Menu Audio.

Specifiche tecniche del Prodotto

Generali

Alimentazione	12V DC (11V to 16V), massa negativa	
Impedenza altoparlanti	4-8 Ω	
Uscita Max di potenza	50W x 4	
Uscita potenza nominale	20W x 4RMS (4 Ω 10%T.H.D)	
Voltaggio Uscita Pre-AMP	2.0V	

Sintonizzatore Radio

Gamma di Frequenza	FM	87.5MHz to 108.0MHz
Sintonizzatore FM	Sensibilità (S/N=20dB)	0.8uV

Sintonizzatore DAB

Gamma di Frequenza	174 - 240MHz	
Sensibilità	-100dBm(Band III)	
Selettività	40dB	

Apparecchio USB

USB	USB2.0 massima velocità	
Uscita USB	Tipo A	
Voltaggio USB	5.0V	
Memoria max. USB	32G	
USB Flash Drive e Hard	FAT16/FAT32	

Bluetooth

Uscita di potenza	Class 2	
Banda di frequenza	2.4000 Ghz - 2.4835GHz ISM Band	
Gamma	3 metri (spazi liberi)	
Standard	Specifiche Bluetooth 2.1	
Profili compatibili Bluetooth	Viva voce (HFP) A2DP(Advanced Audio Distribution Profile) AVRCP1.3(Audio/Video Remote Control Profile)	

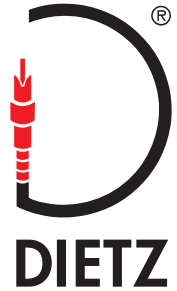

RETRO300 DAB/BT
RETRO301 DAB/BT

**Récepteur numérique de média Bluetooth
compatible USB/MP3/WMA**

Mode d'Emploi

Aperçu de l'Unité

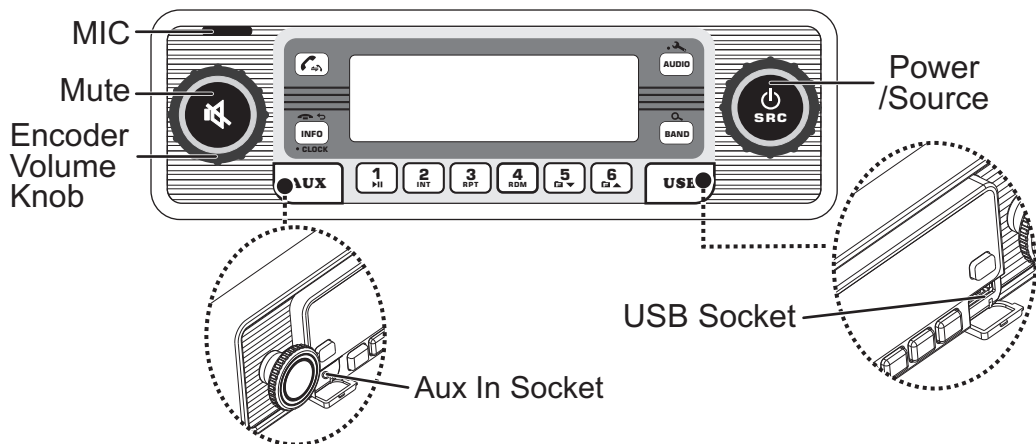

	<ul style="list-style-type: none"> • Appuyez sur pour couper le volume ou le rétablir. • Tournez pour régler le volume 												
	<p>Appuyez pour répondre ou recomposez un appel, appuyez et maintenez pour transférer l'appel.</p>												
	<ul style="list-style-type: none"> • Tuner Mode: Appuyez pour visualiser les infos reçues par le RDS. • DAB Mode: Appuyez plusieurs fois pour afficher les infos envoyées par une station radio DAB. • Lecture des Media: Appuyez pour les infos tag iD3. • Mains libres BT: Appuyez pour refuser ou terminer un appel. • Retournez à l'élément précédent. • Appuyez et maintenez pour visualiser l'horloge 												
	<p>Appuyez pour accéder au Menu Audio, appuyez et maintenez pour accéder au Menu du Système.</p>												
	<ul style="list-style-type: none"> • Tuner Mode: Sélectionnez les bandes FM(FM1/FM2/FM3). Appuyez et maintenez pour accéder à la modalité Mémorisation automatique (Auto-Store), les six stations ayant le signal le plus fort seront sauvées dans la chaîne présélectionnée de façon automatique. • DAB Mode: Sélectionnez une bande (DAB1, DAB2 or DAB3). Appuyez et maintenez pour accéder à la liste des stations sauvées. • Lecture Media: Appuyez pour accéder à la fonction Recherche de vos répertoires /fichiers musicaux. 												
	<ul style="list-style-type: none"> • Allumez l'appareil. Appuyez et maintenez pour l'éteindre. • Sélectionnez la source disponible. • Tuner Mode: Tournez "Saisir" (enter) vers la Recherche automatique (Auto Seek) maintenez pour accéder à la recherche manuelle (Manual Seek). • Lecture des Media: Tournez pour repérer en bas/haut, maintenez pour avancer ou rétrocéder rapidement. 												
	<ul style="list-style-type: none"> • Tuner Mode: Appuyez sur le boutons numériques pour rappeler les stations présélectionnées. Maintenez pour mémoriser la station courante. • DAB Mode : Appuyez sur les taches numériques pour mémoriser la station • Lecture des Media Playback: Appuyez sur les taches numériques pour les opérations: <table border="0" style="width: 100%; text-align: center;"> <tr> <td></td> <td></td> <td></td> <td></td> <td></td> <td></td> </tr> <tr> <td>Play/Pause</td> <td>Intro</td> <td>Repet.</td> <td>Aleatoire</td> <td>Répertoire Bas</td> <td>Répertoire Haut</td> </tr> </table>							Play/Pause	Intro	Repet.	Aleatoire	Répertoire Bas	Répertoire Haut
Play/Pause	Intro	Repet.	Aleatoire	Répertoire Bas	Répertoire Haut								





Écouter la radiodiffusion sonore numérique (DAB)

La radiodiffusion sonore numérique (DAB) permet l'émission de la radio numérique par l'intermédiaire d'un réseau d'émetteurs. Elle assure un choix nombreux, une meilleure qualité audio et plus d'informations.





La première fois que vous allumez la modalité DAB.

- Appuyez  sur ce bouton plusieurs fois pour sélectionner DAB.
 - ↳ Le système effectue une analyse automatique.
 - ↳ Toute station DAB est mémorisée.
 - ↳ La radio se syntonise sur la première station détectée.





Analyse des stations à l'antenne

- ◆ Maintenez  **AUDIO** pour accéder au Menu de Système.
- ◆ Appuyez  **AUDIO** plusieurs fois jusqu'à l'affiche [**SCAN** ]
- ◆ Appuyez  le produit lance la numérisation des stations à l'antenne DAB, qui seront mémorisées dans la mémoire flash.

Allumez/Éteignez l'alimentation d'antenne 12V On/Off

- ◆ Maintenez  **AUDIO** pour accéder au Menu de Système.
- ◆ Appuyez  **AUDIO** plusieurs fois pour les affiches [**12V ON**] [**12V OFF**].
- ◆ Tournez  pour sélectionner une option et appuyez  pour confirmer.
 - [**12V ON**]: Autoriser l'alimentation d'Antenne (12V).
 - [**12V OFF**]: Désactiver l'alimentation d'Antenne (12V).

Effacer la liste des stations DAB

- ◆ Maintenez  **AUDIO** pour accéder au Menu du Système.
- ◆ Appuyez  **AUDIO** plusieurs fois jusqu'à l'affiche [**PRUNE** ] .
 - Pour effacer les stations de la liste des mémorisées  .
 - Pour sortir du menu de Système  **INFO** appuyez sur cette tache.

• CLOCK

Utiliser l'appareil Bluetooth

Appairage de l'appareil Bluetooth



- ◆ Sur votre appareil compatible Bluetooth, suivez les étapes Recherche des appareils Bluetooth.
- ◆ Sélection de la mention **DIETZ** sur la liste des appareils.
- ◆ Saisissez le mot de passe "**0000**" par défaut, et confirmez.
 - ↳ Si l'Appairage a réussi, la mention **[PAIRED]** paraît sur l'écran LCD du système.

Passer un appel téléphonique

Vous pouvez composer un numéro sur votre téléphone portable.

- ◆ Utilisez votre téléphone portable pour composer le numéro et passer un appel.
- ◆ Une fois que l'appel est terminé, l'écran va afficher le numéro téléphonique et la mention **[CALL→]**.

Réception d'un appel





- ◆ En cas d'appel entrant, le numéro de téléphone va paraître. Si l'appel entrant n'a pas de numéro, la mention **[PHONE IN]** va paraître.
- ◆ Appuyez  pour répondre / accepter l'appel.
- ◆ Pour terminer un appel, appuyez .

Transfert des appels



Il est possible de transférer l'appels des h.p. à votre téléphone portable pendant une conversation. Ceci se fait en appuyant et maintenant le  transfert des h.p. à votre téléphone portable.

Émission audio en continu Bluetooth® (A2DP)

Si l'appareil compatible Bluetooth supporte l'émission audio en continu Bluetooth® (A2DP), vous pouvez écouter la musique sauvee sur l'appareil par la radio. Si l'appareil support également le profil de contrôle vidéo/audio à distance (AVRCP), vous pourrez utiliser les commandes de la radio ou sa télécommande pour écouter la musique sauvee sur l'appareil.

- ◆ Appuyez  sur cette touche pour sélectionner **[BT AUDIO]**.
- ◆ Appuyez  pour démarrer la lecture et encore pour la pause.
- ◆ Tournez  pour repérer vers bas/haut.
- ◆ Appuyez  pour visualiser le titre du morceau.

Régler le Menu configuration du Système

- ◆ Maintenez  **AUDIO** pour accéder au Menu du Système.
- ◆ Appuyez  **AUDIO** plusieurs fois pour sélectionner l'élément à régler.
- ◆ Tournez  pour sélectionner une valeur/option.

Mod. Système	Paramètres Sélectionnables
CLK(Clock Set)	Règle les Heures et les Minutes
Clock Format	Sélectionne le format horaire 12H ou 24H
Beep On/Off	Allume ou éteint le son du bip
DIM (Dimmer)	Règle le niveau de retro illumination de l'écran LCD haut/bas (High/Low)
RESET	Rétablit les paramètres de défaut.
TIMER	Règle le temporiseur (OFF/AUTO/30M/60M/90M). <ul style="list-style-type: none"> ● OFF l'autoradio s'éteint une fois que la voiture a été éteinte. ● AUTO l'autoradio s'éteint en même temps que la voiture, mais vous pouvez allumer l'autoradio (ou l'éteindre) pour une période de 30 minutes. ● 30/60/90 minutes sont les différents lapses de temps une fois que la voiture a été éteinte.
Mod. Tuner	Paramètres Sélectionnables
RDS On/Off	Allume ou éteint la fonction RDS.
PTY ↵ (Program Type)	Dans la modalité PTY, appuyez pour entrer dans le type de programme et tournez le volume pour sélectionner la catégorie que vous préférez.
AF (Alternate Frequencies)	<ul style="list-style-type: none"> ● ON: L'autoradio recherche la station courante mais sur des fréquences ayant un signal plus fort automatiquement. ● OFF: Éteint la fonction AF
TA (Traffic Announcement)	<ul style="list-style-type: none"> ● ON: Lors des annonces sur le trafic, l'appareil passe automatiquement au tuner (en option à la modalité courante) et commence à les transmettre. Une fois que les annonces sont terminées, l'appareil en revient à la modalité précédente automatiquement. ● OFF: Aucune interruption de la modalité courante.
CT (Clock Time)	<ul style="list-style-type: none"> ● ON: Allume l'horloge RDS. L'horaire affiché sur l'appareil sera synchronisé avec l'horaire de la station RDS. ● OFF: Éteint l'horloge RDS.
Loc On/Off	<ul style="list-style-type: none"> ● ON : Seulement les stations ayant un signal très fort seront transmises. L'indicateur Local va s'allumer. ● OFF: Toutes les stations, ayant un signal fort ou faible, seront transmises.
Area	Sélectionnez le pays dans lequel vous vous trouvez: EUROPE; ASIE; MOYEN ORIENT; AUSTRALIE; USA; LATIN; JAPAN; RUSSIE;
Mod. BT	Paramètres Sélectionnables
RE-CON ↵ DIS-CON ↵	Cette fonctions permet de Reconnecter ou Disconnecter un portables apairé ou l'appareil Bluetooth manuellement.
UNPAIR ↵	Pour déconnecter le portable apairé.

Écouter un appareil extérieur

Jouer un appareil USB

- ◆ Ouvrez le couvercle USB et insérez l'appareil USB.
- ◆ Appuyez sur  pour sélectionner la modalité USB, l'unité commence à jouer les morceaux de l'appareil USB.

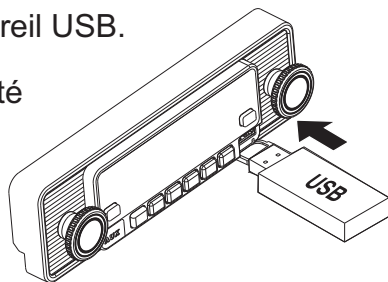

Écouter par l'entrée extérieure auxiliaire

- ◆ Appuyez sur  pour sélectionner la modalité AUDIO IN.
- ◆ Allumez le composant extérieur de façon à démarrer la lecture.

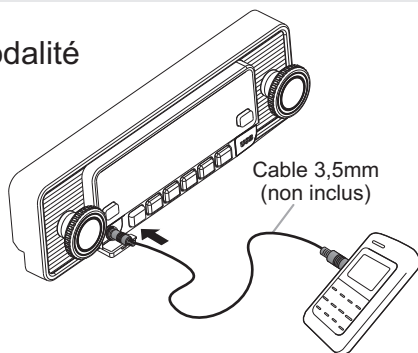

Charge de 1A du téléphone portable par USB

- ◆ Ouvrez le couvercle USB et insérez le iPhone/ Smartphone dans la prise USB
- ◆ Une fois que le iPhone/Smartphone est connecté et reconnu, il commence à se charger

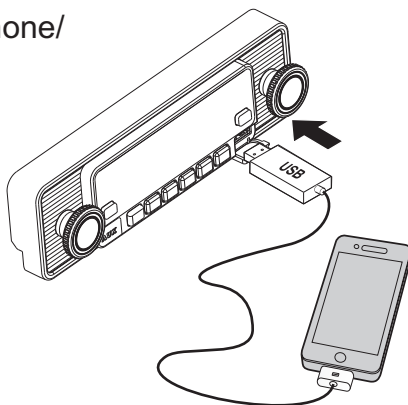

NOTE

La connexion USB peut charger les téléphones mais ne peut décoder les fichiers musicaux mémorisés dans le téléphone

Installer l'Unité



Pliez les pour garder l'entretoise à sa place.

Panneau de contrôle

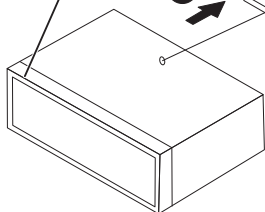

Entretoise

1

Vis

Tableau de bord

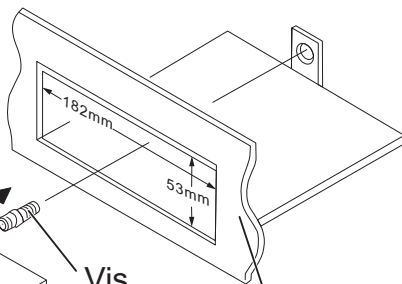

Retirez l'Unité

Démontage



Schéma câblage







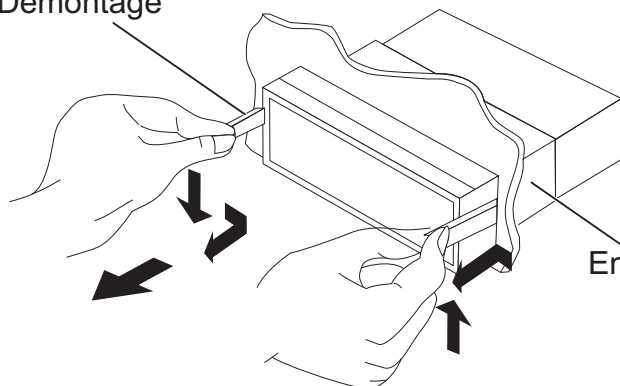

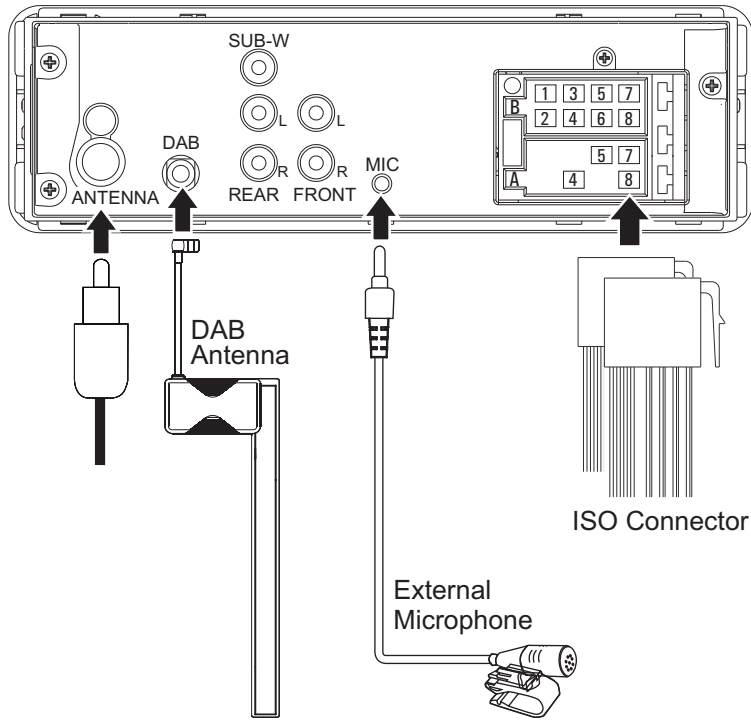
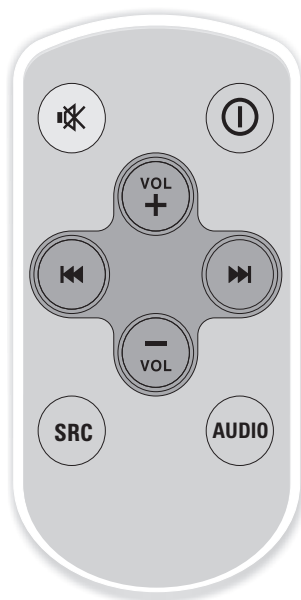

Tableau de câblage du connecteur ISO

Pin	Couleur et Fonction		Pin	Couleur et Fonction	
A4	Jaune	Batterie(+)	B1/B2	Violet ⊕ Violet/Noir ⊖	HP Derrière droit
A5	Bleu	Connectez à la droitborne du système de l'ampli ou au relais d'antenne (Max 150mA/12VDC)	B3/B4	Grey ⊕ Grey/Noir ⊖	HP Avant
A7	Rouge	Allumage(ACC)	B5/B6	Blanc ⊕ Blanc/Noir ⊖	HP Avant gauche
A8	Noir	Masse	B7/B8	Vert ⊕ Vert/Noir ⊖	HP Derrière gauche

Fonctionnement de la Télécommande



	Appuyez pour mettre en mute ou rétablir le volume.
	Allumez ou éteignez l'Unité.
	Appuyez pour augmenter le volume.
	Appuyez pour diminuer le volume.
	<ul style="list-style-type: none">◆ Tuner Mode: Appuyez pour accéder à la modalité Auto Seek, maintenez pour accéder à la modalité Manual Seek.◆ Lecture des Media: Appuyez pour suivre de haut en bas, maintenez pour avancer / reculer rapidement.
	Sélectionnez la Source disponible.
	Appuyez pour accéder au Menu Audio.

Spécifications du Produit

General

Alimentation	12V DC (11V to 16V), masse negative	
Impédance des haut-parleurs	4-8 Ω	
Sortie max de puissance	50W x 4	
Sortie de puissance nom.	20W x 4RMS (4 Ω 10%T.H.D)	
Voltage sortie Pré-Ampli	2.0V	

Tuner Radio

Gamme de Fréquence	FM	87.5MHz to 108.0MHz
Tuner FM	Sensibilité (S/N=20dB)	0.8uV

Tuner DAB

Gamme de Fréquence	174 - 240MHz	
Sensibilité	-100dBm(Band III)	
Sélectivité	40dB	

Appareil USB

USB	USB2.0 Full speed	
SortieUSB	Type A	
Voltage USB	5.0V	
Taille Mémoire Max. USB	32G	
Lecteur Flash USB et Hard	FAT16/FAT32	

Bluetooth

Puissance en sortie	Class 2	
Bande de Fréquence	2.4000 Ghz - 2.4835GHz ISM Band	
Gamme	3 mètres (espaces libres)	
Standard	Spécification Bluetooth 2.1	
Compatible avec profils Bluetooth	Profile Mains-Libres (HFP) A2DP(Advanced Audio Distribution Profile- l'émission audio en continu Bluetooth®) AVRCP1.3(Audio/VideoRemote Control Profile -profil de contrôle vidéo/audio à distance)	

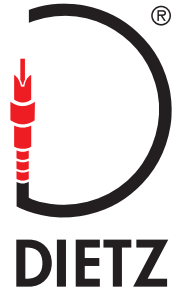





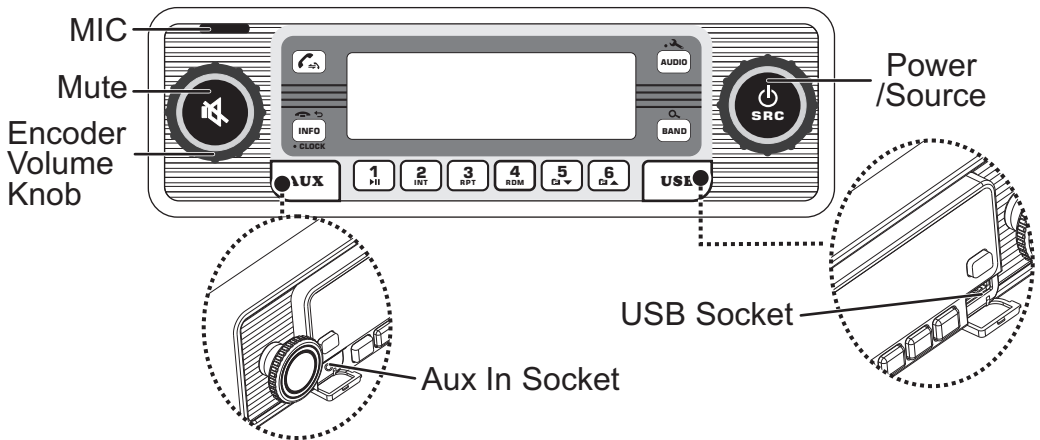

RETRO300 DAB/BT
RETRO301 DAB/BT

**Radio de coche Bluetooth con receptor
Medios digitales USB / MP3 / WMA**

Manual del usuario

Guía de la Unidad



 <ul style="list-style-type: none"> • Presione para silenciar o restaurar el volumen • Gire para ajustar el volumen 												
 <p>Presione para contestar o vuelva a realizar una llamada, presione y mantenga presionada para transferir la llamada.</p>												
 <ul style="list-style-type: none"> • Modo de sintonizador: presione para ver la información recibida por el RDS. • Modo DAB: presione repetidamente para ver la información disponible transmitida por una estación de radio DAB en la pantalla. • Reproducción de medios: presione para ver etiquetas iD3. • BT manos libres: presione para rechazar/finalizar una llamada. • Regrese a la entrada anterior. • Mantenga presionado para ver el reloj. 												
 <p>Presione para acceder al menú de audio, mantenga presionado para acceder al menú del sistema.</p>												
 <ul style="list-style-type: none"> • Modo de sintonizador: seleccione las bandas de FM (FM1/FM2/FM3). Mantenga presionado para acceder al modo de almacenamiento automático. Las seis estaciones con la señal más fuerte en la banda seleccionada se almacenarán automáticamente en el canal preestablecido. • Modo DAB: seleccione las bandas (DAB1, DAB2 o DAB3). Mantenga presionado para acceder a la lista de estaciones almacenadas. • Reproducción de medios: presione para acceder o buscar carpetas/archivos de música. 												
 <ul style="list-style-type: none"> • Encienda el aparato. Mantenga presionado para apagarlo. • Seleccione la fuente disponible. • Modo de sintonizador: gire enter en el modo de búsqueda automática, sintonice y mantenga presionado para ingresar al modo de búsqueda manual. • Reproducción multimedia: gire para desplazarse hacia arriba/abajo, sintonice y mantenga presionado para avanzar / retroceder rápidamente. 												
<p>Preset Numeric Buttons</p> <ul style="list-style-type: none"> • Modo de sintonizador: presione los botones numéricos para recuperar las emisoras preseleccionadas. Mantenga presionados los botones numéricos para almacenar la estación actual. • Modo DAB: presione las teclas numéricas para almacenar la estación actual. • Reproducción de medios: presione los botones numéricos para las siguientes operaciones: <table border="0" style="width: 100%; text-align: center;"> <tr> <td>1 HI</td> <td>2 INT</td> <td>3 RPT</td> <td>4 RDM</td> <td>5 CA</td> <td>6 CB</td> </tr> <tr> <td>Reproducir /Pausa</td> <td>Introducción</td> <td>Repetir</td> <td>Carpeta Aleatoria</td> <td>Carpeta Anterior</td> <td>Carpeta Siguiete</td> </tr> </table>	1 HI	2 INT	3 RPT	4 RDM	5 CA	6 CB	Reproducir /Pausa	Introducción	Repetir	Carpeta Aleatoria	Carpeta Anterior	Carpeta Siguiete
1 HI	2 INT	3 RPT	4 RDM	5 CA	6 CB							
Reproducir /Pausa	Introducción	Repetir	Carpeta Aleatoria	Carpeta Anterior	Carpeta Siguiete							





Escuchar las transmisiones digitales de AUDIO (DAB)

El Audio Digital Broadcasting (DAB) es un modo de radio digital que funciona a través de una red de transmisores. Ofrece la posibilidad de una opción más amplia, excelente calidad de audio y más información.





Para usar por primera vez el modo DAB

- Toque  esta tecla en el dispositivo para seleccionar DAB.
 - ↳ El Sistema escanea automáticamente.
 - ↳ Todas las estaciones DAB disponibles se almacenan.
 - ↳ La radio sintoniza la primera estación disponible.



Escanear estaciones en el aire

- ◆ Mantener la presión  **AUDIO** para entrar en el Menú del Sistema.
- ◆ Presionar  **AUDIO** hasta encontrar esta función [**SCAN** ].
- ◆ Debe presionar  porque el dispositivo escanea las estaciones de radio DAB en el aire, las estaciones detectadas se almacenan en la memoria flash.

Encender la fuente de alimentación de la antena de 12V

- ◆ Mantener la  **AUDIO** presión para entrar en el Menú del Sistema.
- ◆ Hacer  **AUDIO** presión hasta encontrar [**12V ON**] o [**12V OFF**].
- ◆ Gira  para seleccionar y presiona para  confirmar.
 - [**12V ON**]: Encender la fuente de alimentación de la antena (12V).
 - [**12V OFF**]: Apagar la fuente de alimentación de la antena (12V).

Cancelar la lista de las estaciones DAB

- ◆ Mantener la presión  **AUDIO** para entrar en el Menú del Sistema.
- ◆ Hacer  **AUDIO** presión hasta encontrar [**PRUNE** ].
 - Para cancelar las estaciones de la lista usar la tecla .
 - Para salir del Menú del  Sistema.
• **CLOCK**

Utilizar el dispositivo Bluetooth

Realizar el Pairing del dispositivo Bluetooth



- ◆ En su dispositivo con Bluetooth, siga los pasos a continuación.
- ◆ Busca los dispositivos con Bluetooth.
- ◆ En la lista de dispositivos seleccione **DIETZ**.
Ingrese la contraseña predeterminada **"0000"**, y luego confirme.
↳ Si la conexión se realiza completamente aparecerá **[PAIRED]** en la pantalla LCD del sistema.

Realizar una llamada

Es posible teclear un número con tu teléfono móvil.

- ◆ Use su teléfono móvil para marcar el número y hacer una llamada
- ◆ Una vez terminado, se muestran el número y la escritura **[CALL---** en la pantalla.

Recibir una llamada

- ◆ En el caso de una llamada entrante, se muestra el número de la persona que llama, si no, se mostrará en la pantalla **[PHONE IN]**.
- ◆ Con  esta tecla se responde/acepta la llamada.
- ◆ Con esta Minuscula Tecla se termina  la conversación.





Transferencia de llamadas

Es posible transferir la llamada desde los altavoces del automóvil al teléfono móvil durante una conversación telefónica, usando esta tecla.



- ◆  Simplemente presione y mantenga presionada la tecla para transferirlo.

Transmisión de audio Bluetooth A2DP

Si el dispositivo Bluetooth conectado admite el formato Perfil de distribución de audio avanzado (A2DP), puede escuchar la música almacenada en el dispositivo a través de la unidad. Si el dispositivo también admite la función de Perfil de control remoto de audio y video (AVRCP), puede usar los controles de la radio del automóvil o su control remoto para reproducir la música almacenada en el dispositivo.

- ◆ Hacer contin  ua presión para seleccionar **[BT AUDIO]**.
- ◆ Presiona  para reproducir y nuevamente para poner en pausa.
- ◆ Para desplazarse hacia arriba  o hacia abajo gira esta perilla.
- ◆ Presiona  para ver el título o la información de la canción.

Ajuste la configuración del Menú

- ◆ Mantener la  **AUDIO** presión para entrar en el Menú.
- ◆ Presionar  **AUDIO** varias veces para seleccionar el artículo deseado.
- ◆ Girar la perilla  para seleccionar un valor / opción.

Modo Sistema	Configuraciones seleccionables
CLK(Reloj)	Ajustar horas y minutos
Formato del Reloj	Seleccionar el formato de hora (12H o 24H)
Pitido activado /desactivado	Activar o desactivar el pitido
DIM (atenuador)	Ajustar el nivel de retroiluminación de la pantalla LCD entre Alto o Bajo
Reiniciar	Restaurar la configuración predeterminada de fábrica
Temporizador	Para configurar el apagado (OFF / AUTO / 30M / 60M / 90M). <ul style="list-style-type: none"> ● OFF se apaga inmediatamente cuando se apaga el automóvil. ● AUTO permite que la radio se apague junto con el automóvil, pero es posible encenderla nuevamente (o apagarla) durante un período de 30 minutos. ● 30/60/90 son las opciones en minutos para mantener la radio del automóvil encendida después de apagar el automóvil.

Sintonizador	Configuraciones seleccionables
RDS On/Off	Activa o desactiva la función RDS.
PTY ↵ (Tipo de programa)	Una vez que se activa el modo PTY, presione y gire la perilla de volumen para acceder a la categoría de programa seleccionada.
AF (Frecuencias Alternativas)	<ul style="list-style-type: none"> ● ENCENDIDA: la unidad buscará automáticamente la misma estación pero en frecuencias con una señal más fuerte. ● APAGADA: apaga la función AF.
TA (Anuncio de tráfico)	<ul style="list-style-type: none"> ● ENCENDIDA: en caso de anuncios de tráfico, la radio se posiciona automáticamente en la estación que los transmite (a pesar del modo en progreso) y comienza a transmitirlos. Una vez terminado, vuelve automáticamente al modo anterior. ● APAGADA: no habrá interrupciones de tráfico.
CT (Hora del reloj)	<ul style="list-style-type: none"> ● ENCENDIDA: activa el reloj RDS. La hora que se muestra en la pantalla se sincroniza con la de la estación RDS que se está escuchando. ● APAGADA: desactiva el reloj RDS.
Localizador activado /desactivado	<ul style="list-style-type: none"> ● ENCENDIDA: Detecta solo las estaciones con la señal más fuerte. El indicador local se iluminará. ● APAGADA: se detectarán estaciones cuya señal será fuerte o débil.

Area	Selecciona el tipo de área (continente) en el que se encuentra: EUROPA; ASIA; MEDIO ORIENTE; AUSTRALIA; EE.UU.; AMÉRICA; JAPÓN; RUSIA;
ModoBT	Configuraciones seleccionables
RE-CON ↵ DIS-CON ↵	Esta función le permite volver a conectar o desconectar dispositivos que hayan efectuado Pairing y Bluetooth manualmente.
UNPAIR ↵	Para eliminar el Pairing del teléfono inteligente conectado.

Escuchar dispositivo externos

Reproducir un dispositivo con salida USB

- ◆ Abra la tapa de la entrada USB e inserte el dispositivo USB.
- ◆ Presione  para seleccionar el modo USB, la unidad comenzará a reproducir desde el dispositivo USB.

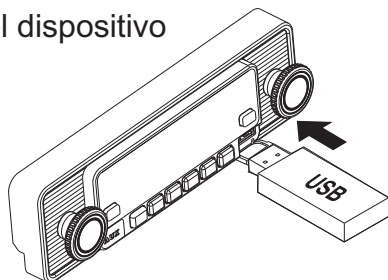

Escuche a través de la entrada AUX externa

- ◆ Presione  para seleccionar la modalidad AUDIO IN.
- ◆ Encienda el dispositivo externo y comience la reproducción.

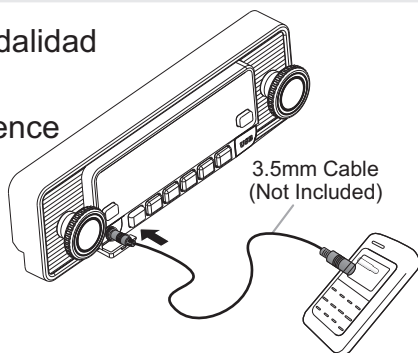

Cargar teléfonos inteligentes a través de USB (1A)

- ◆ Abrir la tapa de la entrada USB e insertar el teléfono inteligente a través de USB.
- ◆ Una vez que el teléfono está conectado, comienza a cargar.

NOTE

La toma USB puede cargar el teléfono, pero no puede reproducir archivos de música almacenados en el mismo.

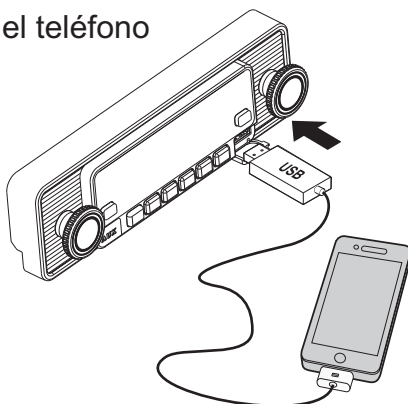

Instalación de la Unidad

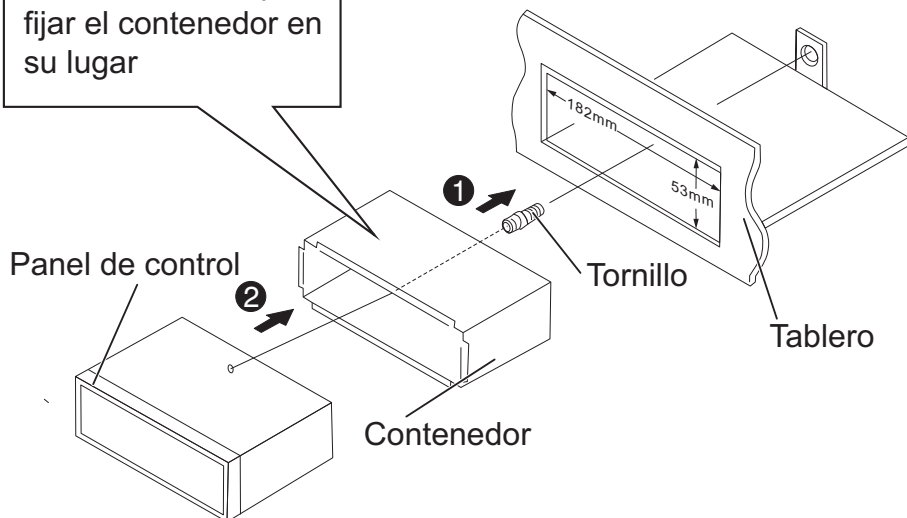

Retirar la Unidad

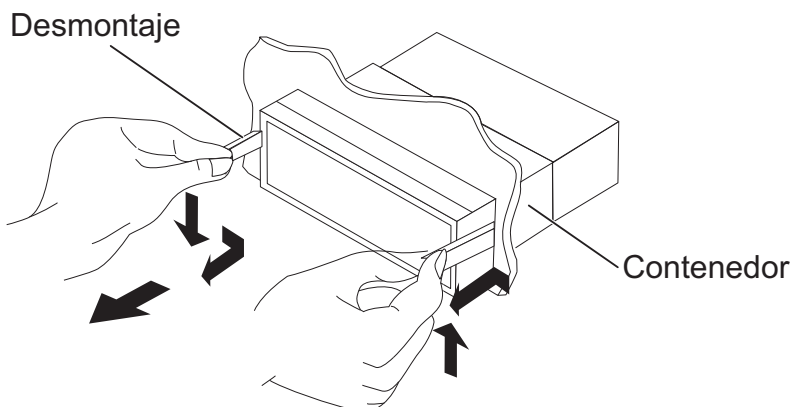

Esquema eléctrico



Diagrama de conexión Conector ISO

Pin	Color yFunción	Pin	Color yFunción	
A4	Amarillo Batería(+)	B1/B2	Violeta ⊕ Violeta /Negro ⊖	Altavoz posterior Derecho
A5	Azul Conectar al terminal de control del sistema de Altavoz anterior de potencia (APM) o al relé de antena automática (Max 150MA/12VDC)	B3/B4	Gris ⊕ Gris/Negro ⊖	Altavoz de anterior Derecho
A7	Rojo Encender(ACC)	B5/B6	Blanco ⊕ Blanco/Negro ⊖	Altavoz anterior Izquierdo
A8	Negro Conexión a tierra	B7/B8	Verde ⊕ Verde/Negro ⊖	Altavoz posterior Izquierdo

Funcionamiento del Control Remoto

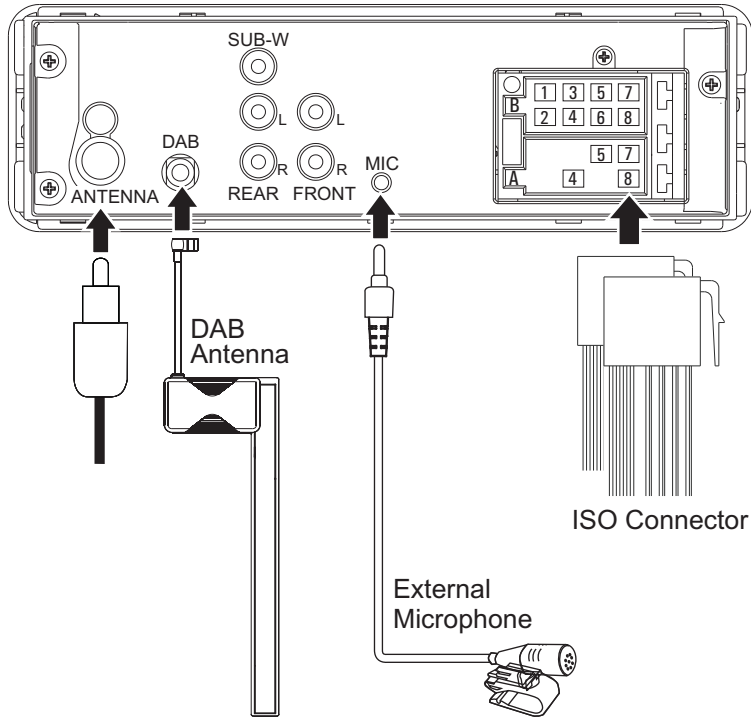
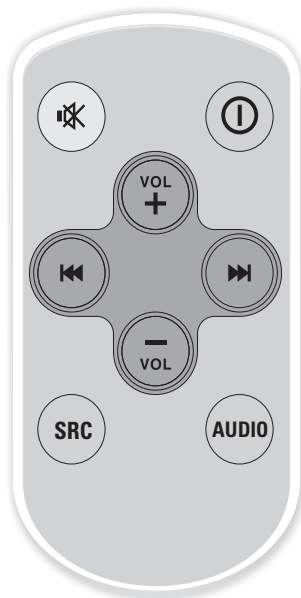

	Presione para silenciar o restaurar el volumen.
	Enciende o apaga el aparato.
	Presione para subir el volumen.
	Presione para bajar el volumen.
	<ul style="list-style-type: none">♦ Modo de sintonizador: presione para ingresar al modo de búsqueda automática (Auto Seek) presione y mantenga presionado para acceder a la búsqueda manual (Manual Seek).♦ Reproducción de medios: presione para desplazarse hacia arriba / abajo, presione y mantenga presionado para avanzar/ retroceder rápidamente.
SRC	Seleccione la fuente disponible.
AUDIO	Presione para acceder al Menu Audio.

Especificaciones técnicas del producto

Generales

Alimentación	12V DC (11V to 16V), carga negativa	
Impedancia del altavoz	4-8 Ω	
Salida máxima de potencia	50W x 4	
Salida potencia nominal	20W x 4RMS (4 Ω 10%T.H.D)	
Voltaje de salida Pre-AMP	2.0V	

Sintonizador de Radio

Gama de Frecuencia	FM	87.5MHz to 108.0MHz
Sintonizador FM	Sensibilidad (S/N=20dB)	0.8uV

Sintonizador de DAB

Gama de Frecuencia	174 - 240MHz	
Sensibilidad	-100dBm(Band III)	
Selectividad	40dB	

Aparato USB

USB	USB2.0 Full speed	
Salida USB	Type A	
Voltaje USB	5.0V	
Memoria máxima USB	32G	
Unidad flash USB y disco duro	FAT16/FAT32	

Bluetooth

Salida de potencia	Clase2	
Banda de frecuencia	2.4000 Ghz - 2.4835GHz ISM Band	
Gama	3 metros (espacios libres)	
Estándar	especificaciones de Bluetooth 2.1	
Perfiles compatibles con Bluetooth	Alto parlante (HFP) A2DP(Perfil de distribución de audio avanzado) AVRCP1.3(Perfil de control remoto de audio / video)	



Audiotechnik Dietz Vertriebs-GmbH
Maybachstr. 10
D-67269 Grünstadt
Germany
order@dietz.biz
www.dietz.biz